

Data Sheet

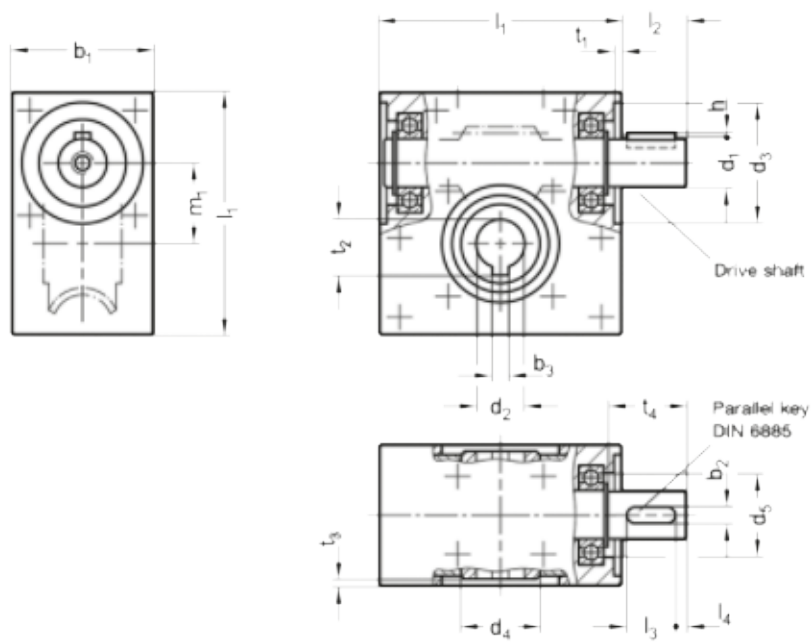

Article number: 20397520A1230AN
 Description: E+G Worm Gear Reducer
 GN 3975-20-A-12-30-AN

Measures



b1 = 35	gear ratio=i = 30	t2 = 13.8
b2 = 4	h = 1.5	t3 = 1.6
b3 = 4	l1 = 60	t4 = 18.3
d1 = 12	l2 = 16	weight (g) = 438
d2 = 12	l3 = 12	
d3 = 30	l4 = 3	
d4 = 20	m1 = 20	
d5 = 27.4	t1 = 2	